



CONSELHO MUNICIPAL DE TRÂNSITO E TRANSPORTE DE CASA BRANCA/SP

Lei Complementar Nº 3.440 de 17 de Novembro de 2017

Rua Capitão Horta, 758, Centro, Casa Branca/SP.

Tel.: (19) 3671 4659 E-mail: segtran@casabranca.sp.gov.br

RESOLUÇÃO COMUTTRAN Nº 002/2022

DISPÕE SOBRE O HORÁRIO, PERÍODO E PERÍMETRO DO ESTACIONAMENTO ROTATIVO PAGO 'ZONA AZUL', COM FULCRO NA LEI COMPLEMENTAR 3.440/2017.

O CONSELHO MUNICIPAL DE TRÂNSITO E TRANSPORTE DE CASA BRANCA - COMUTTRAN, criado pela Lei Complementar nº 3.440, de 14 de Novembro de 2017, órgão colegiado de poder normativo, consultivo e participativo da política municipal de trânsito de Casa Branca, de composição paritária entre Governo e Sociedade Civil;

CONSIDERANDO o artigo 31º da Lei Municipal Nº 3.440 de 14 de Novembro de 2017, bem como o disposto no Regimento Interno deste órgão;

RESOLVE:

Art. 1º O estacionamento rotativo pago de Casa Branca, denominado 'Zona Azul', funcionará de segunda à sexta-feira, das 8h (oito horas) às 18h (dezoito horas) e nos sábados das 8h (oito horas) às 14h (quatorze horas).

§1º Nos domingos e feriados não haverá cobrança e nem limitação do tempo de utilização dos estacionamentos situados na Área Azul.

§2º Em épocas especiais e/ou datas comemorativas e em conformidade com as necessidades locais, o número de vagas e os horários estabelecidos neste artigo poderão ser ampliados ou reduzidos por ato próprio do Poder Executivo.

Art. 2º O período máximo de estacionamento contínuo numa mesma vaga será de 2 (duas) horas, devendo constar nas placas de sinalização de regulamentação.

Parágrafo único – É obrigatória a retirada do veículo após o término do período máximo estabelecido para a vaga ocupada, ficando o infrator sujeito as penalidades previstas na Lei Federal nº 9.503, de 1997.

Art. 3º As áreas de estacionamento rotativo pagas se limitarão às seguintes vias e logradouros públicos:



CONSELHO MUNICIPAL DE TRÂNSITO E TRANSPORTE DE CASA BRANCA/SP

Lei Complementar Nº 3.440 de 17 de Novembro de 2017

Rua Capitão Horta, 758, Centro, Casa Branca/SP.

Tel.: (19) 3671 4659 E-mail: segtran@casabranca.sp.gov.br

• Rua São Paulo

Total de vagas carro: 25

Total de vagas moto: 7



• Praça Rui Barbosa

Total de vagas carro: 21 vagas 45°

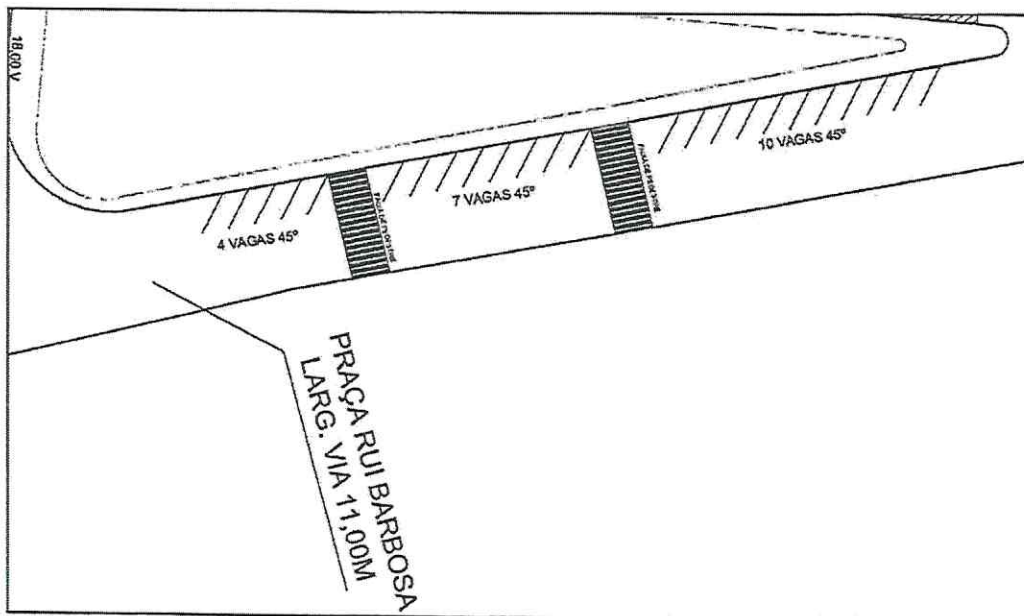



CONSELHO MUNICIPAL DE TRÂNSITO E TRANSPORTE DE CASA BRANCA/SP

Lei Complementar Nº 3.440 de 17 de Novembro de 2017

Rua Capitão Horta, 758, Centro, Casa Branca/SP.

Tel.: (19) 3671 4659 E-mail: segtran@casabranca.sp.gov.br

- **Rua Altino Arantes (Quadra 1)**

Total de vagas carro: 36

Total de vagas moto: 38



- **Rua Altino Arantes (Quadra 2)**

Total de vagas carro: 20

Total de vagas moto: 21



- **Rua Altino Arantes (Quadra 3)**

Total de vagas carro: 17

Total de vagas moto: 14





CONSELHO MUNICIPAL DE TRÂNSITO E TRANSPORTE DE CASA BRANCA/SP

Lei Complementar Nº 3.440 de 17 de Novembro de 2017

Rua Capitão Horta, 758, Centro, Casa Branca/SP.
Tel.: (19) 3671 4659 E-mail: segtran@casabranca.sp.gov.br

- **Rua Altino Arantes (Quadra 4)**

Total de vagas carro: 19

Total de vagas moto: 14



- **Rua Altino Arantes (Quadra 5)**

Total de vagas carro: 19

Total de vagas moto: 13

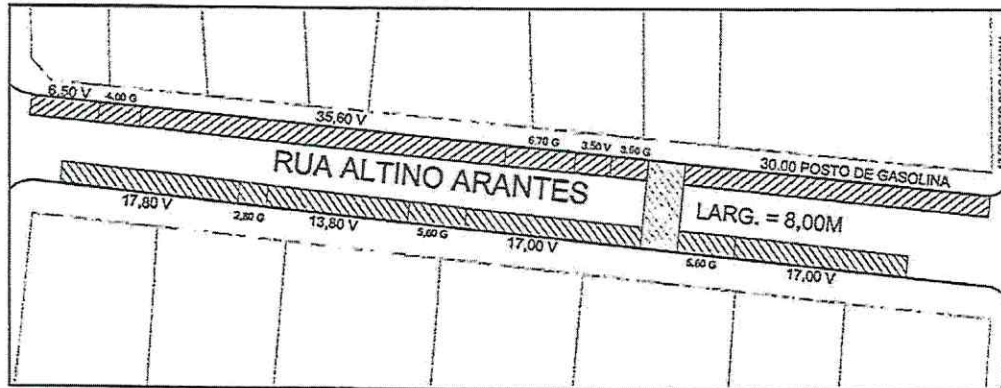

- **Rua Altino Arantes (Quadra 6)**

Total de vagas carro: 24

Total de vagas moto: 13

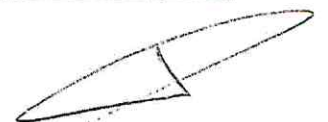
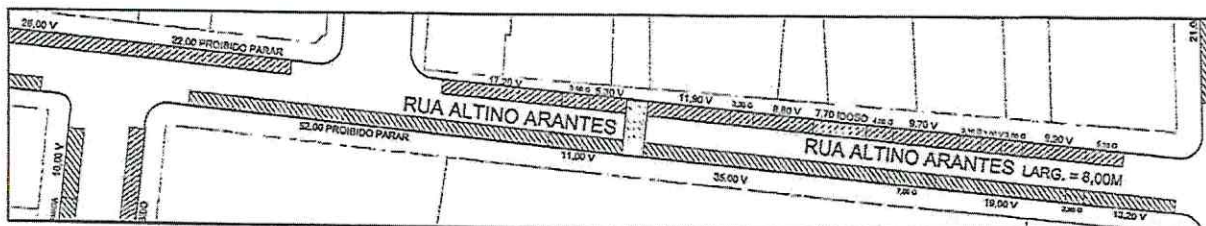



CONSELHO MUNICIPAL DE TRÂNSITO E TRANSPORTE DE CASA BRANCA/SP

Lei Complementar Nº 3.440 de 17 de Novembro de 2017

Rua Capitão Horta, 758, Centro, Casa Branca/SP.
Tel.: (19) 3671 4659 E-mail: segtran@casabranca.sp.gov.br

- **Rua Altino Arantes (Quadra 7)**

Total de vagas carro: 27

Total de vagas moto: 9



- **Rua Altino Arantes (Quadra 8)**

Total de vagas carro: 20

Total de vagas moto: 3



- **Rua Cel José Júlio – Quadra 1**

Total de vagas carro: 41

Total de vagas moto: 17

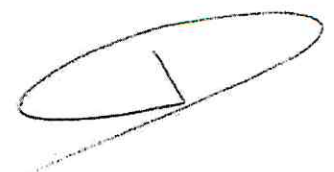
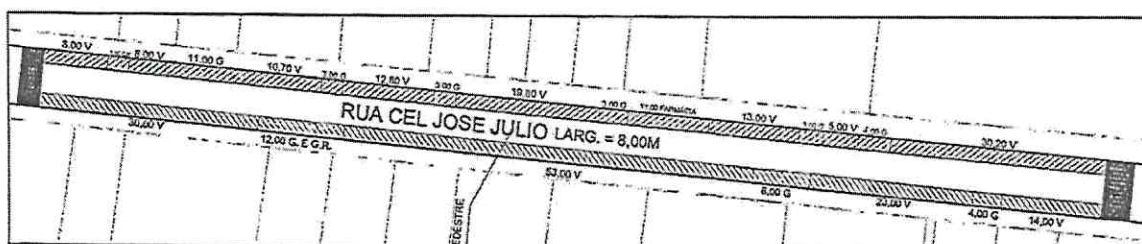



CONSELHO MUNICIPAL DE TRÂNSITO E TRANSPORTE DE CASA BRANCA/SP

Lei Complementar Nº 3.440 de 17 de Novembro de 2017

Rua Capitão Horta, 758, Centro, Casa Branca/SP.

Tel.: (19) 3671 4659 E-mail: segtran@casabranca.sp.gov.br

- **Rua Cel José Júlio – Quadra 2**

Total de vagas carro: 17

Total de vagas moto: 14

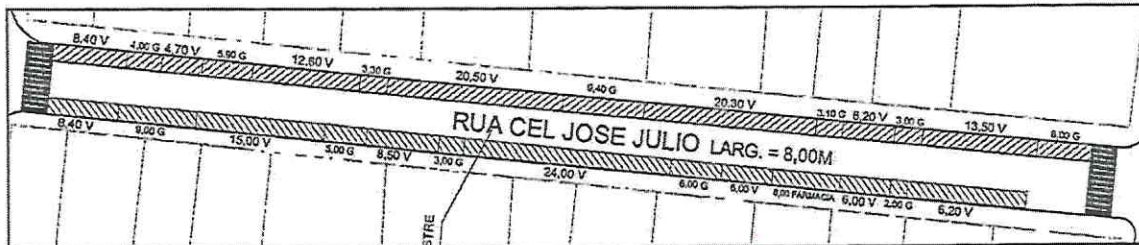

- **Rua Cel José Júlio – Quadra 3**

Total de vagas carro: 20

Total de vagas moto: 16

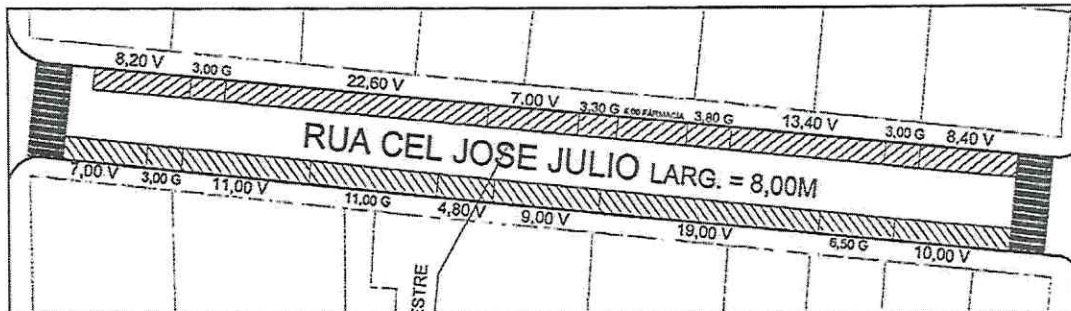

- **Rua Cel José Júlio – Quadra 4**

Total de vagas carro: 18

Total de vagas moto: 4





CONSELHO MUNICIPAL DE TRÂNSITO E TRANSPORTE DE CASA BRANCA/SP

Lei Complementar Nº 3.440 de 17 de Novembro de 2017

Rua Capitão Horta, 758, Centro, Casa Branca/SP.
Tel.: (19) 3671 4659 E-mail: segtran@casabranca.sp.gov.br

- **Rua Cel José Júlio – Quadra 5**
Total de vagas carro: 22
Total de vagas moto: 13

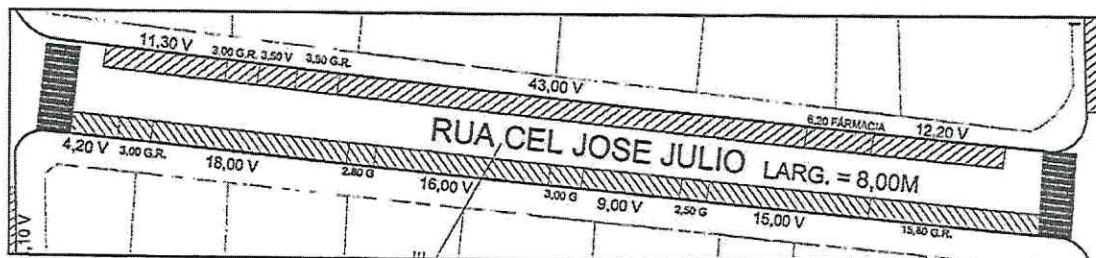

- **Rua Cel José Júlio – Quadra 6**
Total de vagas carro: 30
Total de vagas moto: 9

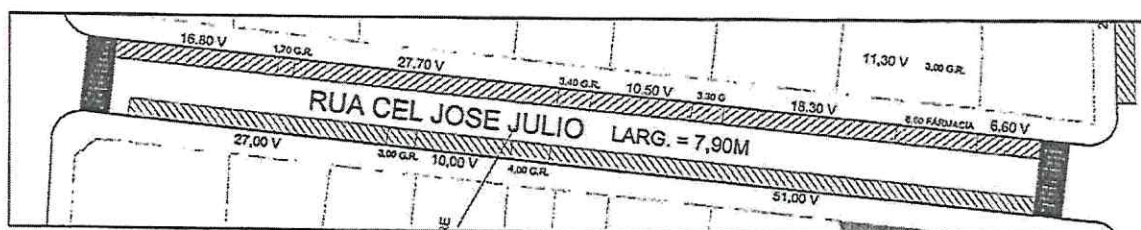

- **Rua Cel José Júlio – Quadra 7**
Total de vagas carro: 39
Total de vagas moto: 7

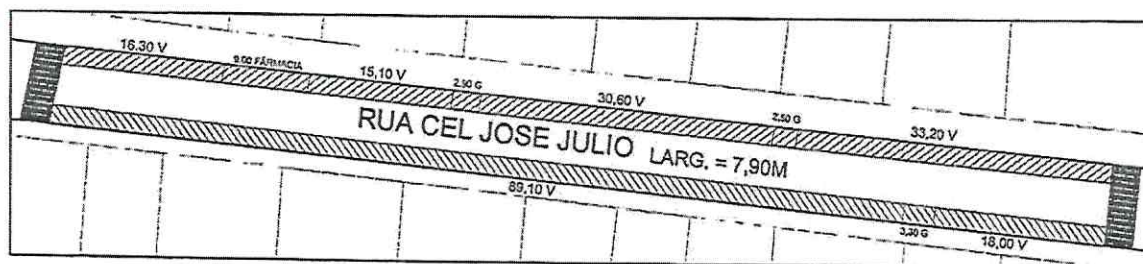



CONSELHO MUNICIPAL DE TRÂNSITO E TRANSPORTE DE CASA BRANCA/SP

Lei Complementar Nº 3.440 de 17 de Novembro de 2017

Rua Capitão Horta, 758, Centro, Casa Branca/SP.

Tel.: (19) 3671 4659 E-mail: segtran@casabranca.sp.gov.br

- **Rua Cel José Júlio – Quadra 8**

Total de vagas carro: 15

Total de vagas moto: 21

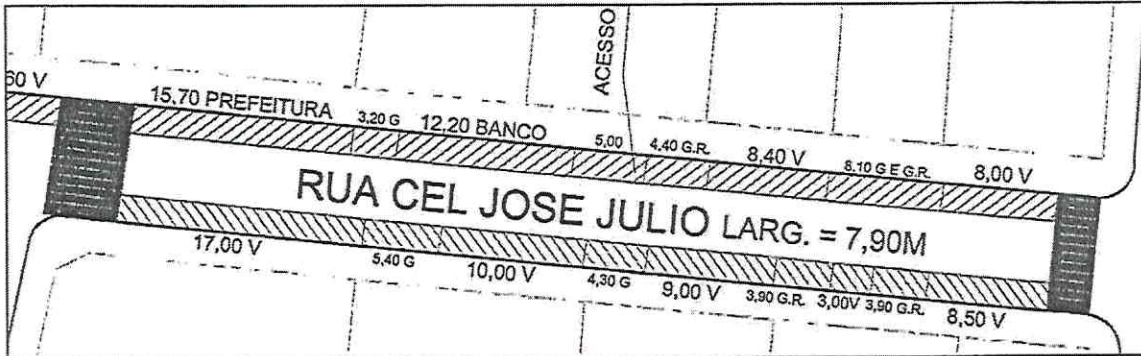

- **Rua Cel José Júlio – Quadra 9**

Total de vagas carro: 9

Total de vagas moto: 12

7 vagas de táxi 90° e 2 vagas exclusivas 90°



- **Rua Ipiranga – Quadra 1**

Total de vagas carro: 27

Total de vagas moto: 21

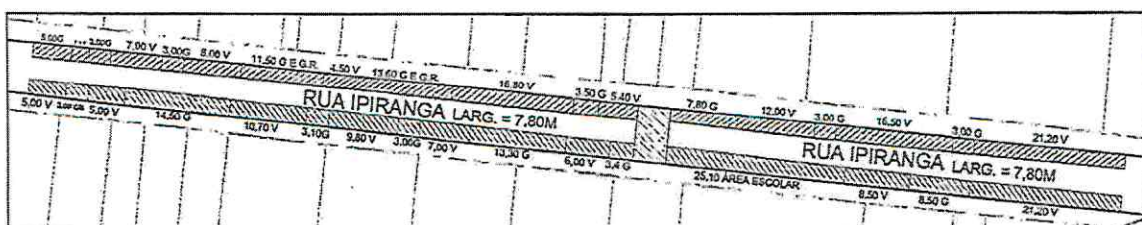



CONSELHO MUNICIPAL DE TRÂNSITO E TRANSPORTE DE CASA BRANCA/SP

Lei Complementar Nº 3.440 de 17 de Novembro de 2017

Rua Capitão Horta, 758, Centro, Casa Branca/SP.

Tel.: (19) 3671 4659 E-mail: segtran@casabranca.sp.gov.br

- **Rua Ipiranga – Quadra 2**

Total de vagas carro: 19

Total de vagas moto: 23

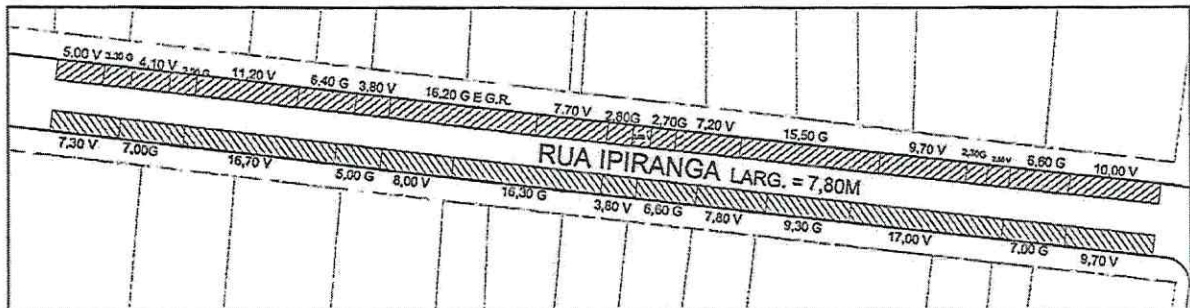

- **Rua Ipiranga – Quadra 3**

Total de vagas carro: 20

Total de vagas moto: 10

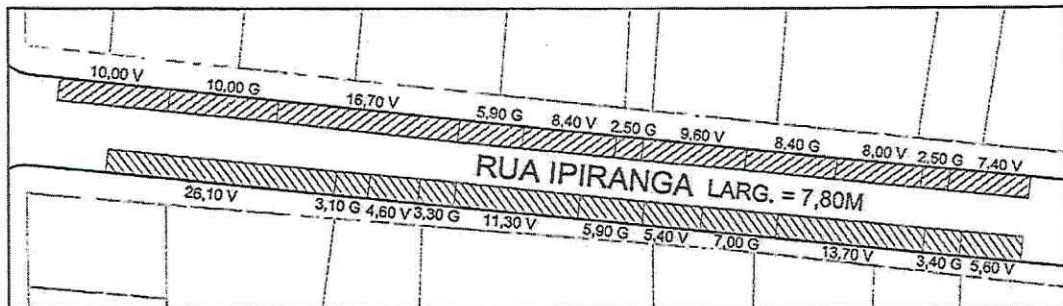

- **Rua Ipiranga – Quadra 4**

Total de vagas carro: 18

Total de vagas moto: 17

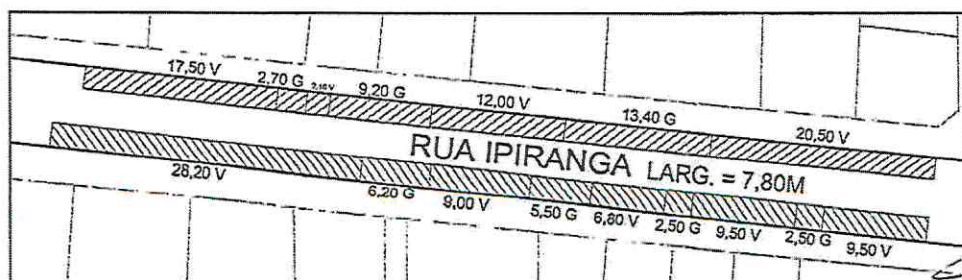



CONSELHO MUNICIPAL DE TRÂNSITO E TRANSPORTE DE CASA BRANCA/SP

Lei Complementar Nº 3.440 de 17 de Novembro de 2017

Rua Capitão Horta, 758, Centro, Casa Branca/SP.
Tel.: (19) 3671 4659 E-mail: segtran@casabranca.sp.gov.br

- **Rua Ipiranga – Quadra 5**
Total de vagas carro: 24
Total de vagas moto: 16

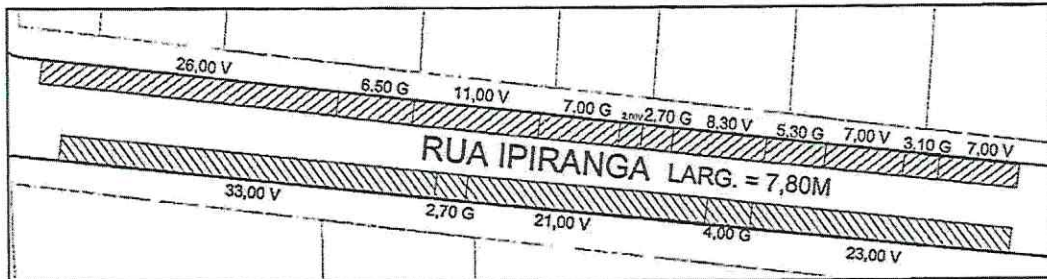

- **Rua Angelo Stefanni – Quadra 1**
Total de vagas carro: 15
Total de vagas moto: 19



- **Rua Angelo Stefanni – Quadra 2**
Total de vagas carro: 14
Total de vagas moto: 4

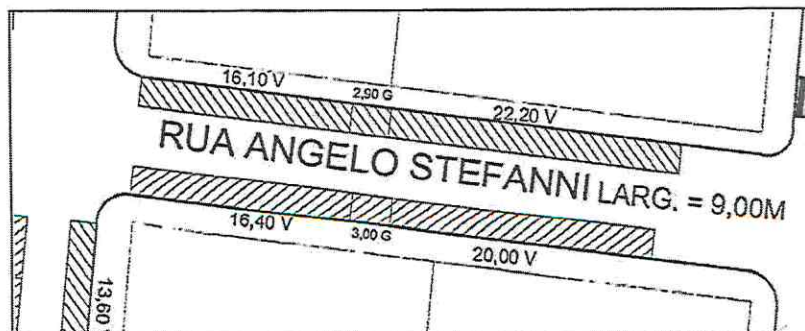



CONSELHO MUNICIPAL DE TRÂNSITO E TRANSPORTE DE CASA BRANCA/SP

Lei Complementar Nº 3.440 de 17 de Novembro de 2017

Rua Capitão Horta, 758, Centro, Casa Branca/SP.

Tel.: (19) 3671 4659 E-mail: segfran@casabranca.sp.gov.br

- **Rua Ângelo Stefanni – Quadra 3**

Total de vagas carro: 11

Total de vagas moto: 21

1 vaga para idoso 1 vaga para veículo oficial



- **Rua José Gerônimo de Vasconcellos – Quadra 1**

Total de vagas carro: 18

Total de vagas moto: 06



- **Rua José Gerônimo de Vasconcellos – Quadra 2**

Total de vagas carro: 9

1 vaga para deficiente físico





CONSELHO MUNICIPAL DE TRÂNSITO E TRANSPORTE DE CASA BRANCA/SP

Lei Complementar Nº 3.440 de 17 de Novembro de 2017

Rua Capitão Horta, 758, Centro, Casa Branca/SP.

Tel.: (19) 3671 4659 E-mail: segtran@casabranca.sp.gov.br

- **Rua José Gerônimo de Vasconcellos – Quadra 3**

Total de vagas carro: 21

Total de vagas moto: 10



- **Rua Manoel Martins – Quadra 1**

Total de vagas carro: 17

Total de vagas moto: 11

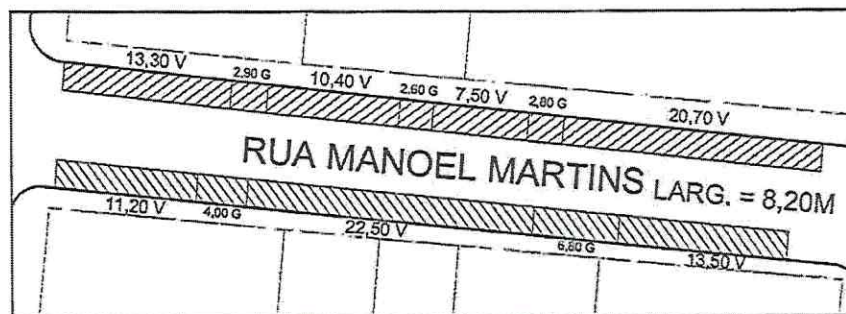

- **Rua Manoel Martins – Quadra 2**

Total de vagas carro: 19

Total de vagas moto: 6

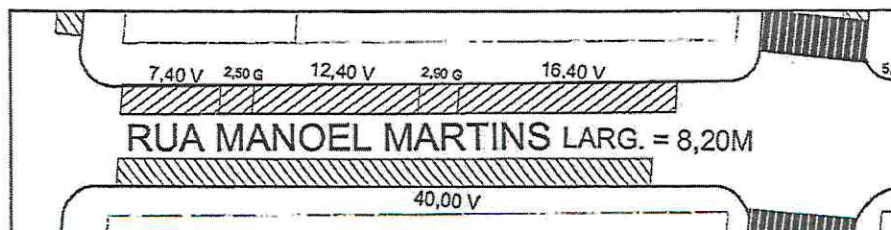



CONSELHO MUNICIPAL DE TRÂNSITO E TRANSPORTE DE CASA BRANCA/SP

Lei Complementar Nº 3.440 de 17 de Novembro de 2017

Rua Capitão Horta, 758, Centro, Casa Branca/SP.

Tel.: (19) 3671 4659 E-mail: segtran@casabranca.sp.gov.br

- **Rua Manoel Martins – Quadra 3**

Total de vagas carro: 19

Total de vagas moto: 10

1 vaga para deficiente físico

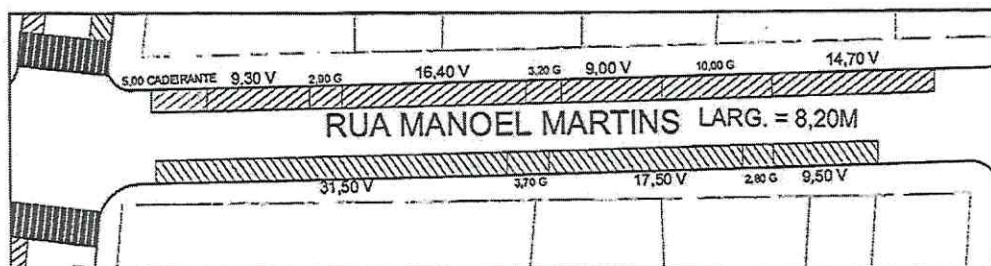

- **Rua Dr. Moacir Troncoso Peres – Quadra 1**

Total de vagas carro: 17

Total de vagas moto: 9

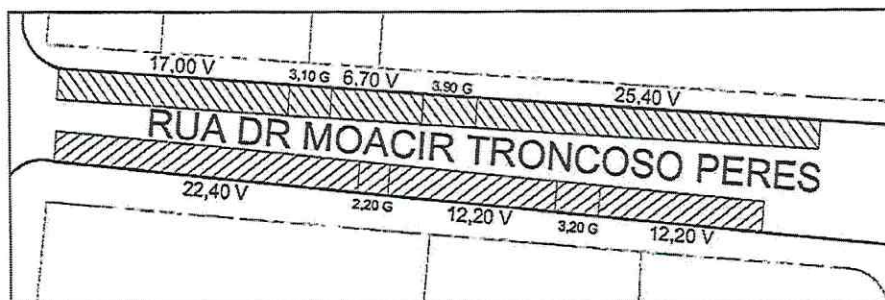

- **Rua Dr. Moacir Troncoso Peres – Quadra 2**

Total de vagas carro: 12

Total de vagas moto: 2

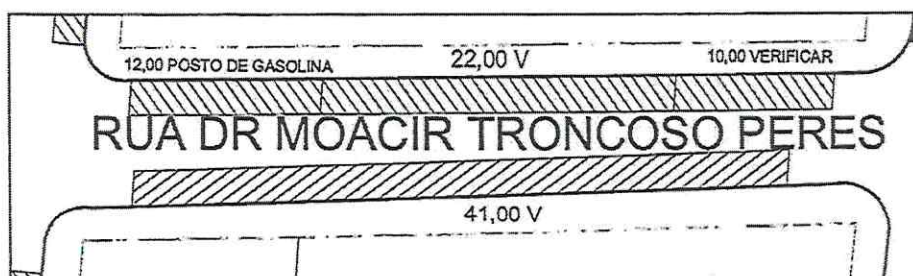



CONSELHO MUNICIPAL DE TRÂNSITO E TRANSPORTE DE CASA BRANCA/SP

Lei Complementar Nº 3.440 de 17 de Novembro de 2017

Rua Capitão Horta, 758, Centro, Casa Branca/SP.

Tel.: (19) 3671 4659 E-mail: segtran@casabranca.sp.gov.br

- **Rua Dr. Moacir Troncoso Peres – Quadra 3**

Total de vagas carro: 17

Total de vagas moto: 17

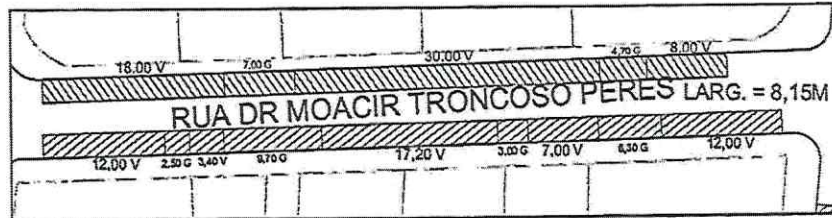

- **Rua Duque de Caxias – Quadra 1**

Total de vagas carro: 21

Total de vagas moto: 16



- **Rua Duque de Caxias – Quadra 2**

Total de vagas carro: 18

Total de vagas moto: 6

1 vaga para idoso

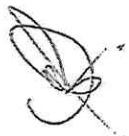



CONSELHO MUNICIPAL DE TRÂNSITO E TRANSPORTE DE CASA BRANCA/SP

Lei Complementar Nº 3.440 de 17 de Novembro de 2017

Rua Capitão Horta, 758, Centro, Casa Branca/SP.

Tel.: (19) 3671 4659 E-mail: segtran@casabranca.sp.gov.br

- **Rua Duque de Caxias – Quadra 3**

Total de vagas carro: 12

Total de vagas moto: 3

1 vaga para deficiente físico.

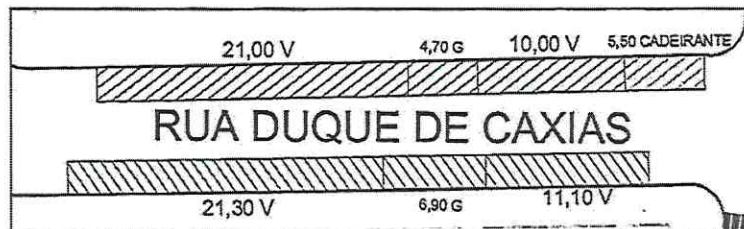

- **Rua Duque de Caxias – Quadra 4**

Total de vagas carro: 25

Total de vagas moto: 16

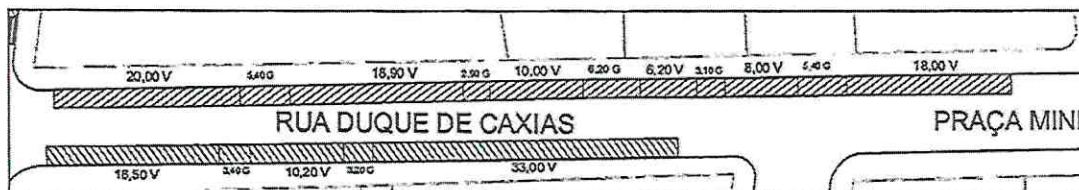

- **Praça Ministro Costa Manso**

Total de vagas carro: 18

Total de vagas moto: 5

2 vagas deficiente físico.





CONSELHO MUNICIPAL DE TRÂNSITO E TRANSPORTE DE CASA BRANCA/SP

Lei Complementar Nº 3.440 de 17 de Novembro de 2017

Rua Capitão Horta, 758, Centro, Casa Branca/SP.

Tel.: (19) 3671 4659 E-mail: segtran@casabranca.sp.gov.br

- **Rua Fioravante Cassiolato**

Total de vagas carro: 29

Total de vagas moto: 15

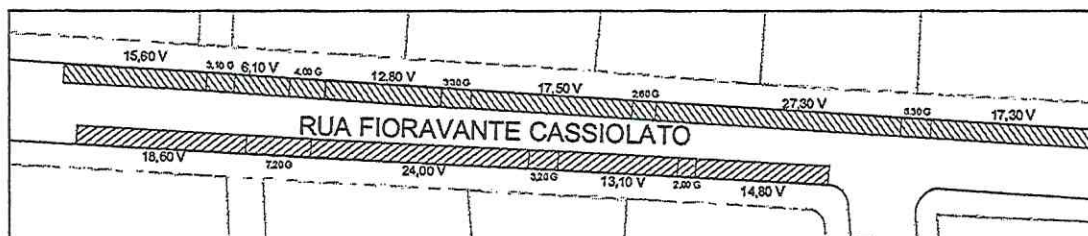

- **Rua Capitão Horta – Quadra 1**

Total de vagas carro: 30

Total de vagas moto: 15

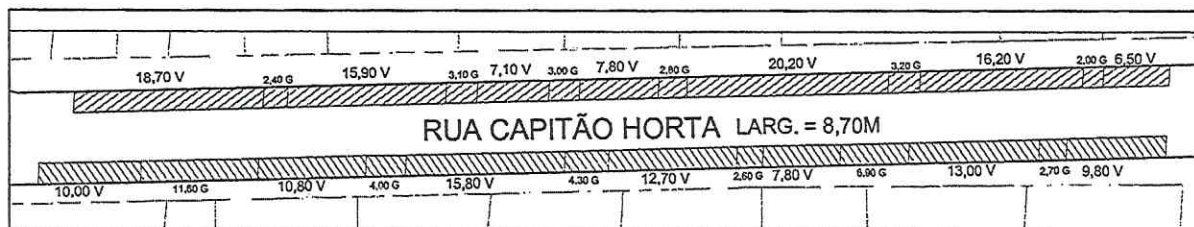

- **Rua Capitão Horta – Quadra 2**

Total de vagas carro: 40

Total de vagas moto: 15

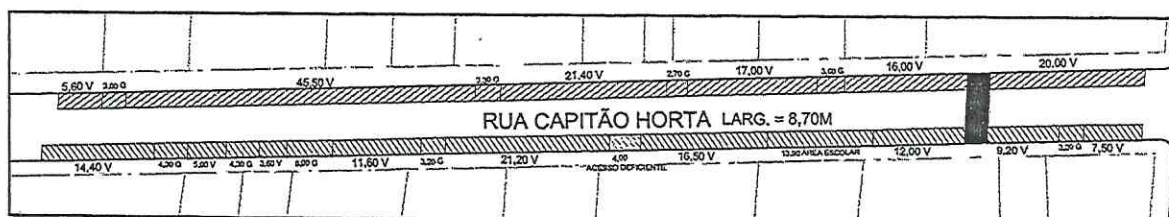



CONSELHO MUNICIPAL DE TRÂNSITO E TRANSPORTE DE CASA BRANCA/SP

Lei Complementar Nº 3.440 de 17 de Novembro de 2017

Rua Capitão Horta, 758, Centro, Casa Branca/SP.
Tel.: (19) 3671 4659 E-mail: segtran@casabranca.sp.gov.br

- **Rua Capitão Horta – Quadra 3**

Total de vagas carro: 37

Total de vagas moto: 18

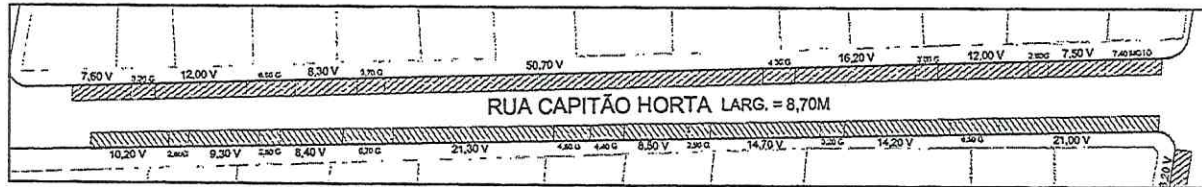

- **Rua Sebastião Antônio de Carvalho**

Total de vagas carro: 19

Total de vagas moto: 14



- **Praça Dr. Barreto - Quadra 1**

Total de vagas carro: 29

Total de vagas moto: 10

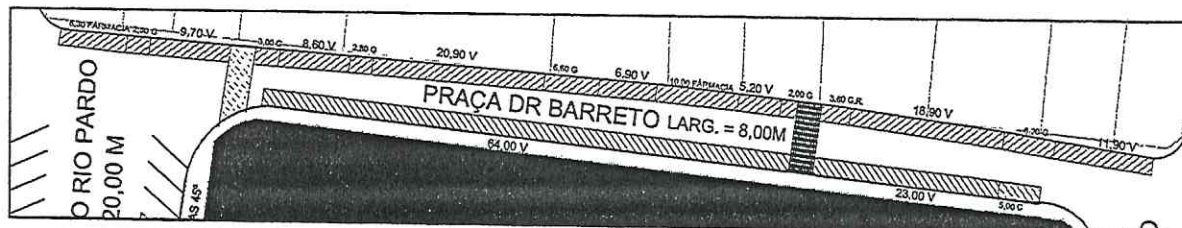



CONSELHO MUNICIPAL DE TRÂNSITO E TRANSPORTE DE CASA BRANCA/SP

Lei Complementar Nº 3.440 de 17 de Novembro de 2017

Rua Capitão Horta, 758, Centro, Casa Branca/SP.
Tel.: (19) 3671 4659 E-mail: segtran@casabranca.sp.gov.br

- **Praça Dr. Barreto - Quadra 2**
Total de vagas carro: 32
Total de vagas moto: 7

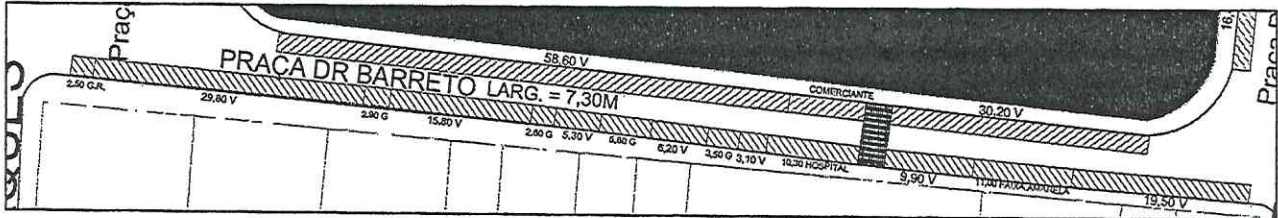

- **Praça Barão do Rio Pardo**
12 vagas 45°



- **Rua Dr. Menezes**
Total de vagas carro: 38
Total de vagas moto: 18

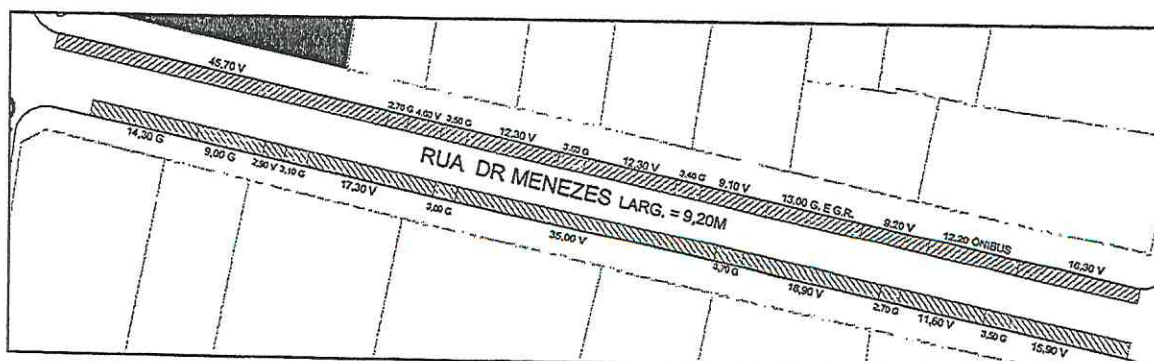



CONSELHO MUNICIPAL DE TRÂNSITO E TRANSPORTE DE CASA BRANCA/SP

Lei Complementar Nº 3.440 de 17 de Novembro de 2017

Rua Capitão Horta, 758, Centro, Casa Branca/SP.
Tel.: (19) 3671 4659 E-mail: segtran@casabranca.sp.gov.br

- **Rua Fernando Musa**
Total de vagas carro: 11
Total de vagas moto: 3
1 vaga para deficiente físico.

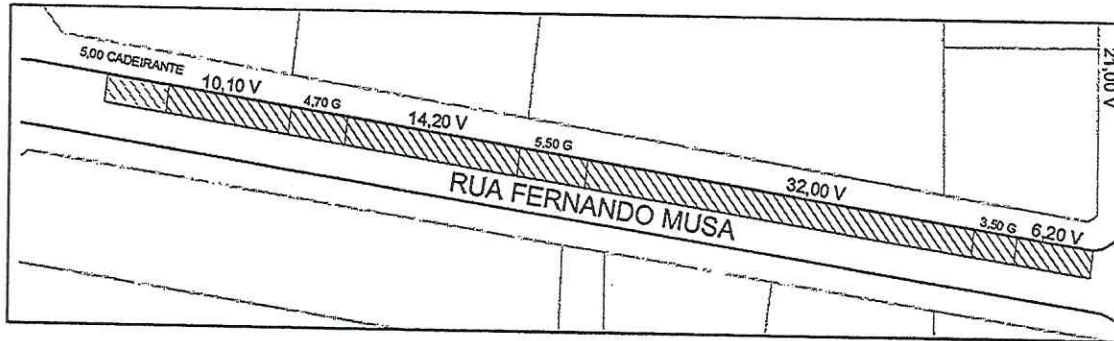

- **Praça Barão de Mogi Guaçu – Quadra 1**
Total de vagas carro: 17
Total de vagas moto: 10



- **Praça Barão de Mogi Guaçu – Quadra 2**
Total de vagas carro: 20
Total de vagas moto: 3





CONSELHO MUNICIPAL DE TRÂNSITO E TRANSPORTE DE CASA BRANCA/SP

Lei Complementar Nº 3.440 de 17 de Novembro de 2017

Rua Capitão Horta, 758, Centro, Casa Branca/SP.
Tel.: (19) 3671 4659 E-mail: segtran@casabranca.sp.gov.br

- **Praça Barão de Mogi Guaçu – Quadra 3**

Total de vagas carro: 9

Total de vagas moto: 8

9 vagas 90° - circular

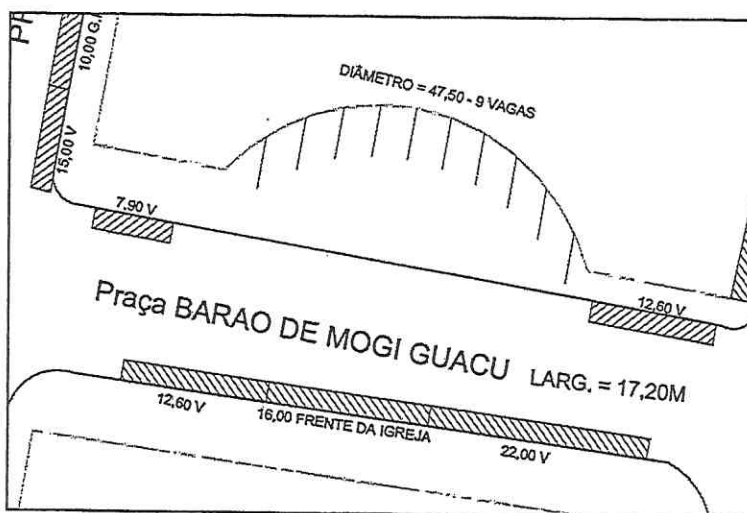

- **Praça Barão de Mogi Guaçu – Quadra 4 = 9,00m**

6 vagas 45°

5 vagas 45°

7 vagas de taxi 45°

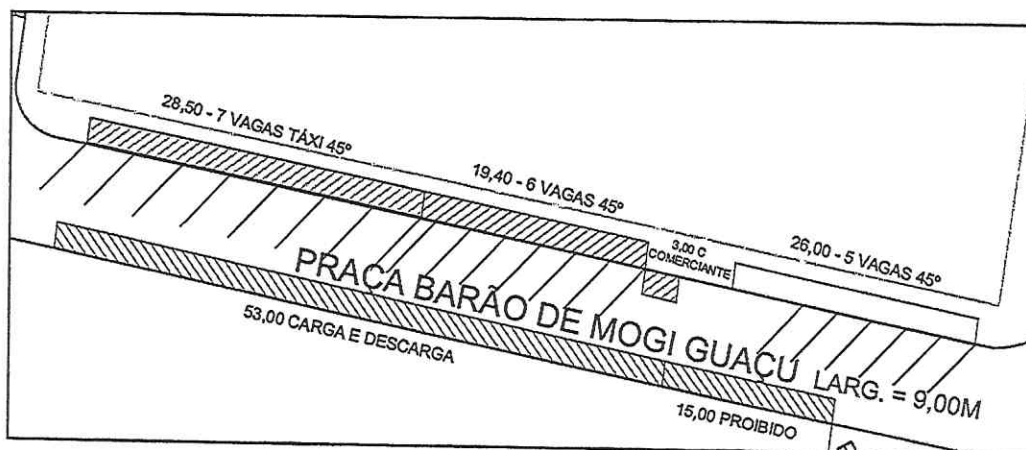



CONSELHO MUNICIPAL DE TRÂNSITO E TRANSPORTE DE CASA BRANCA/SP

Lei Complementar Nº 3.440 de 17 de Novembro de 2017

Rua Capitão Horta, 758, Centro, Casa Branca/SP.

Tel.: (19) 3671 4659 E-mail: segtran@casabranca.sp.gov.br

- **Praça Barão de Mogi Guaçu – Quadra 5**

Total de vagas carro: 1

Total de vagas moto: 3

27 vagas 45°

3 vagas oficiais 45°



- **Rua Pedro de Toledo**

Total de vagas carro: 19

Total de vagas moto: 8



- **Rua Lucio Leonel - Quadra 1**

Total de vagas carro: 09

Total de vagas moto: 4

2 vagas deficiente físico.





CONSELHO MUNICIPAL DE TRÂNSITO E TRANSPORTE DE CASA BRANCA/SP

Lei Complementar Nº 3.440 de 17 de Novembro de 2017

Rua Capitão Horta, 758, Centro, Casa Branca/SP.

Tel.: (19) 3671 4659 E-mail: segfran@casabranca.sp.gov.br

- **Rua Lucio Leonel - Quadra 2**

Total de vagas carro: 7

Total de vagas moto: 2

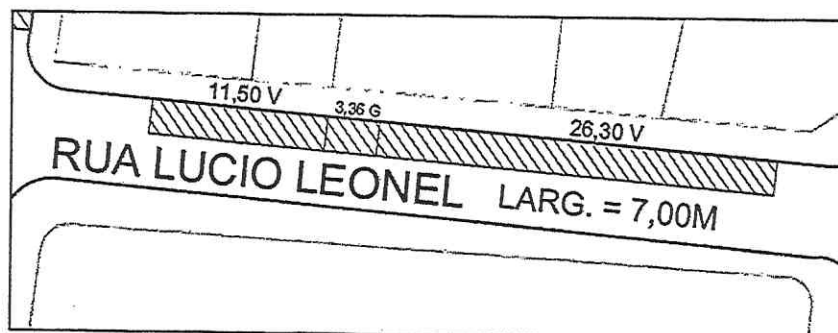

- **Rua Lucio Leonel - Quadra 3**

Total de vagas carro: 6

Total de vagas moto: 4

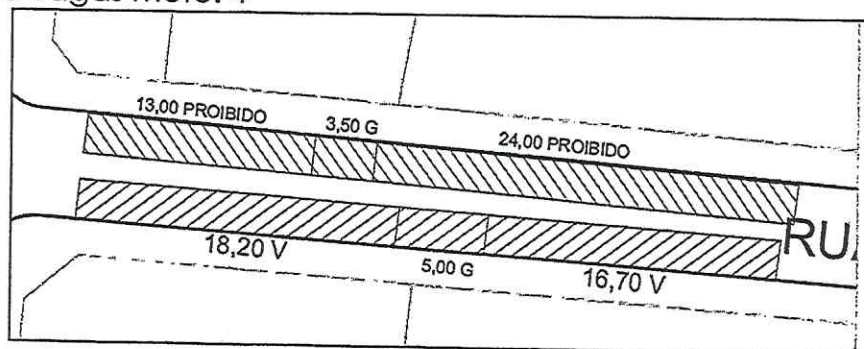

- **Rua Lucio Leonel - Quadra 4**

Total de vagas carro: 13

Total de vagas moto: 11

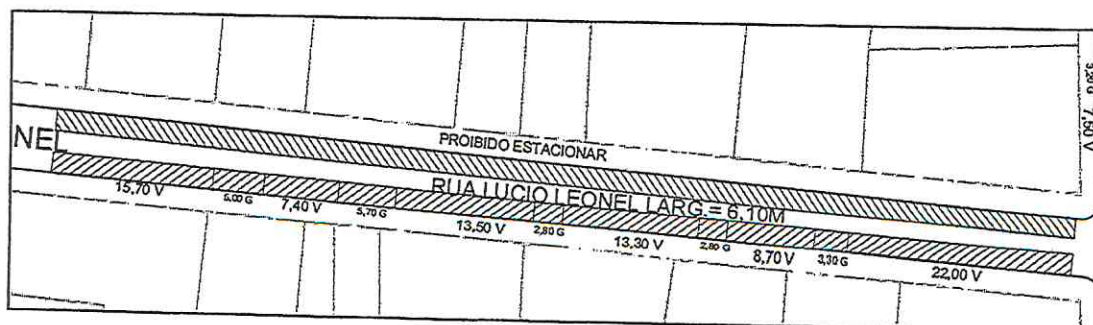



CONSELHO MUNICIPAL DE TRÂNSITO E TRANSPORTE DE CASA BRANCA/SP

Lei Complementar Nº 3.440 de 17 de Novembro de 2017

Rua Capitão Horta, 758, Centro, Casa Branca/SP.
Tel.: (19) 3671 4659 E-mail: segtran@casabranca.sp.gov.br

- **Praça Dr. Carvalho**
Total de vagas carro: 15
Total de vagas moto: 9
29 vagas 45°, área circular

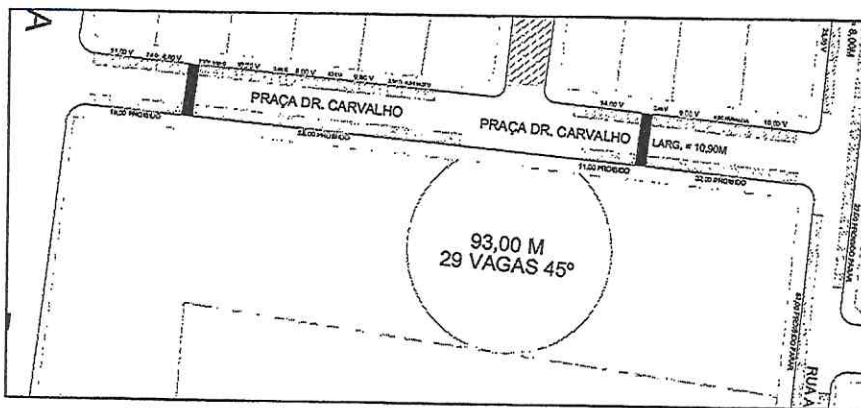

- **Rua Lacerda Franco**
Total de vagas carro: 24
Total de vagas moto: 16

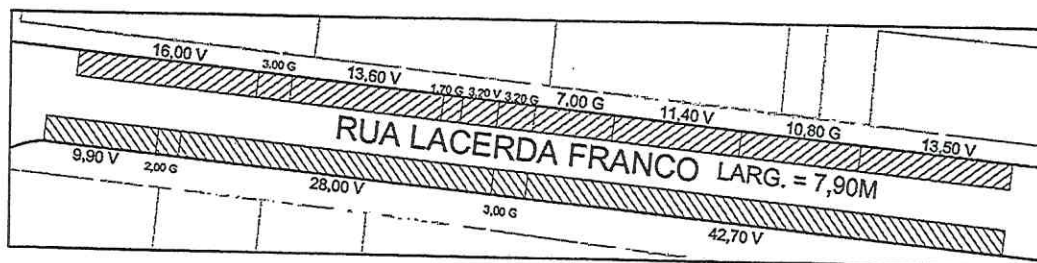



CONSELHO MUNICIPAL DE TRÂNSITO E TRANSPORTE DE CASA BRANCA/SP

Lei Complementar Nº 3.440 de 17 de Novembro de 2017

Rua Capitão Horta, 758, Centro, Casa Branca/SP.
Tel.: (19) 3671 4659 E-mail: segtran@casabranca.sp.gov.br

- **Continuação da Rua Lacerda Franco (sem Saída)**
Total de vagas carro: 9

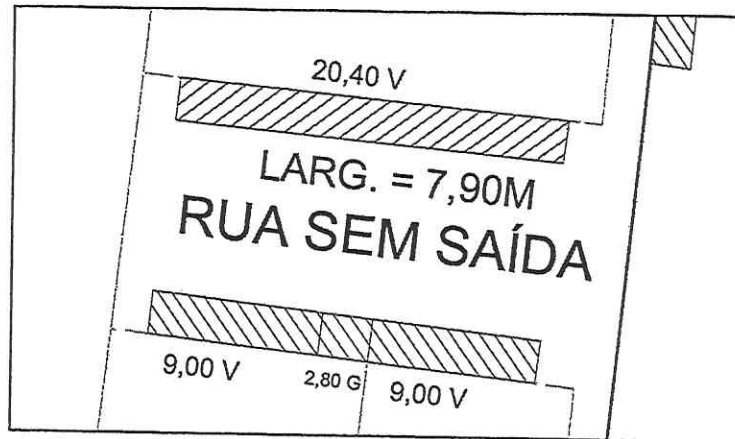

Art. 4º Esta Resolução entra em vigor na data de sua publicação;

Casa Branca, 03 de Maio de 2022.

CLAUDIO RUI PICCOLO
PRESIDENTE DO COMUTTRAN

RESOLUÇÃO FIXADA E ARQUIVADA JUNTO AO ÓRGÃO EXECUTIVO DE TRÂNSITO DO MUNICÍPIO DE CASA BRANCA.

PEDRO JOSÉ DE ANDRADE ORFEI
Secretário Executivo do COMUTTRAN